

SAP on Cloud

Industry-grade HUAWEI CLOUD solution for SAP

CONTENTS

1	Solution Overview	
1.1	Why Cloud ERP	01
1.2	Why HUAWEI CLOUD	03
1.3	Solution Architecture	05
1.4	Application Scenarios	06
1.5	Feature Tree	11
2	Features	
2.1	SAP Certifications	12
2.2	Performance	14
2.3	HA and DR	15
2.4	High Security	16
2.5	Backup and Restoration	17
2.6	SAP Management Tool	19
2.7	Elastic Application Scaling	20
2.8	Integration	21
3	Success Stories	23

1.1 Why Cloud ERP

Enterprises' IT systems are becoming information-based, digital, and intelligent. This will allow IT infrastructure to be flexibly scaled up and down, and is secure, reliable, cost-effective, and intelligent.

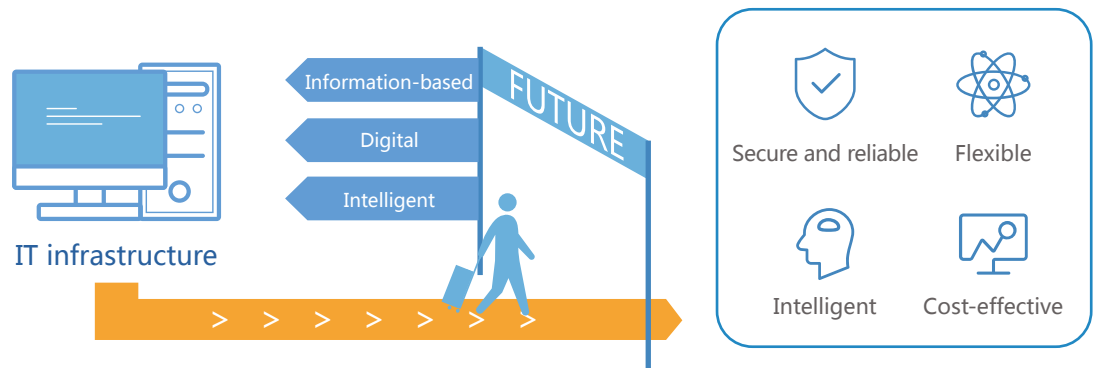

The enterprise resource planning (ERP) system is the core asset of an enterprise IT system, and coordinates financial resources, human resources, and supply chains. Therefore, moving ERP to the cloud is a vital step in IT transformation.

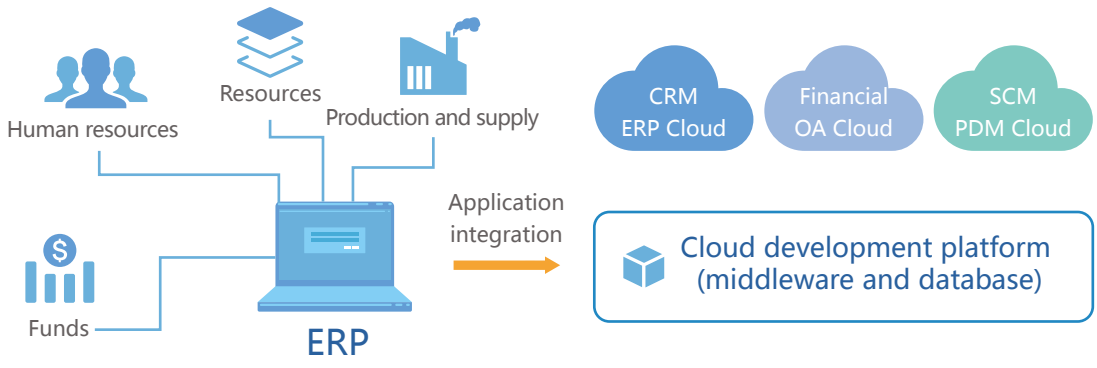

Flexible

Service usage fluctuates around the clock, and resource demands change rapidly as enterprises grow. To cope with these fluctuations, IT infrastructure must be able to flexibly scale up and down. The solution is moving ERP to the cloud.

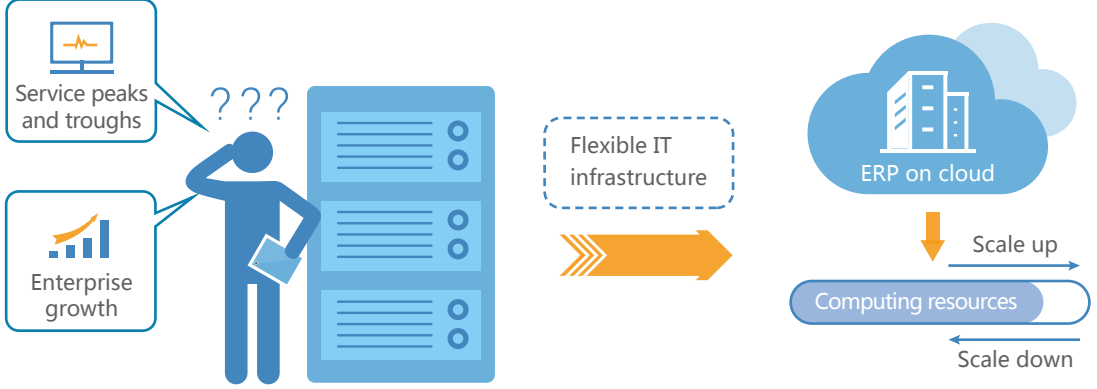

Cost-effective

Cloud ERP reduces total cost of ownership (TCO) by over 30% by reducing hardware costs, time cost of initial deployment, system O&M costs, and lifecycle management costs.

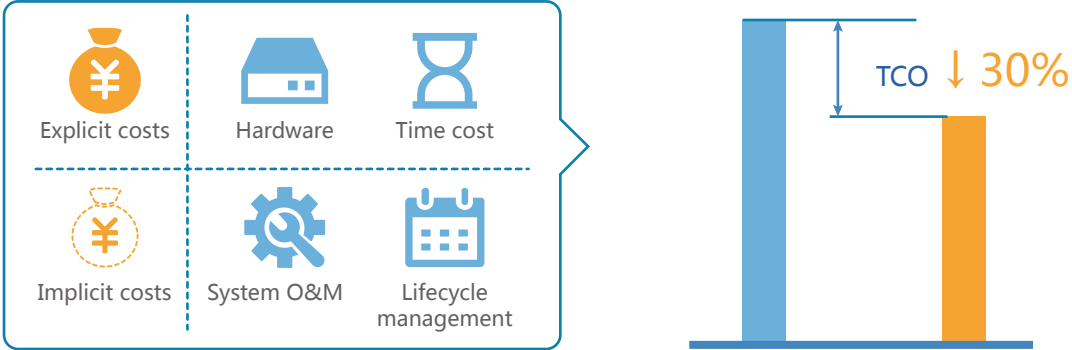

Secure and Reliable

The service level agreement (SLA) is critical to the ERP service. It poses high requirements on continuity and reliability of both upper-layer applications and databases. High availability (HA) and disaster recovery (DR) systems for ERP can be deployed on the cloud to help enterprises remain committed to the SLA.

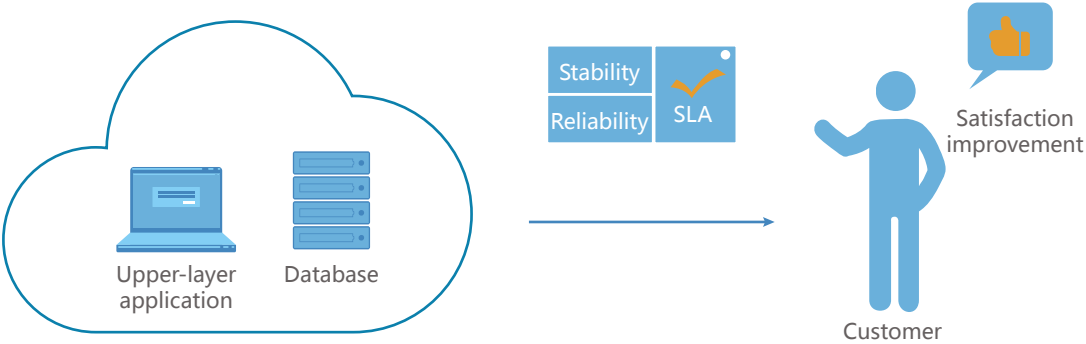

Intelligent

An increasing number of enterprises expect their ERP to integrate with edge-cutting technologies, such as big data, IoT, and AI. This allows the enterprises to respond to ever-changing market and service requirements and achieve efficient, intelligent, and agile digital operations.

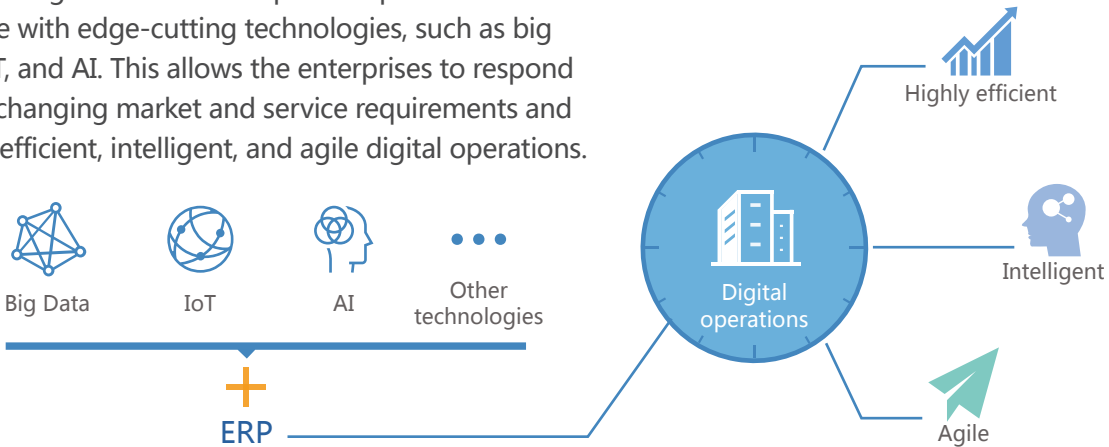





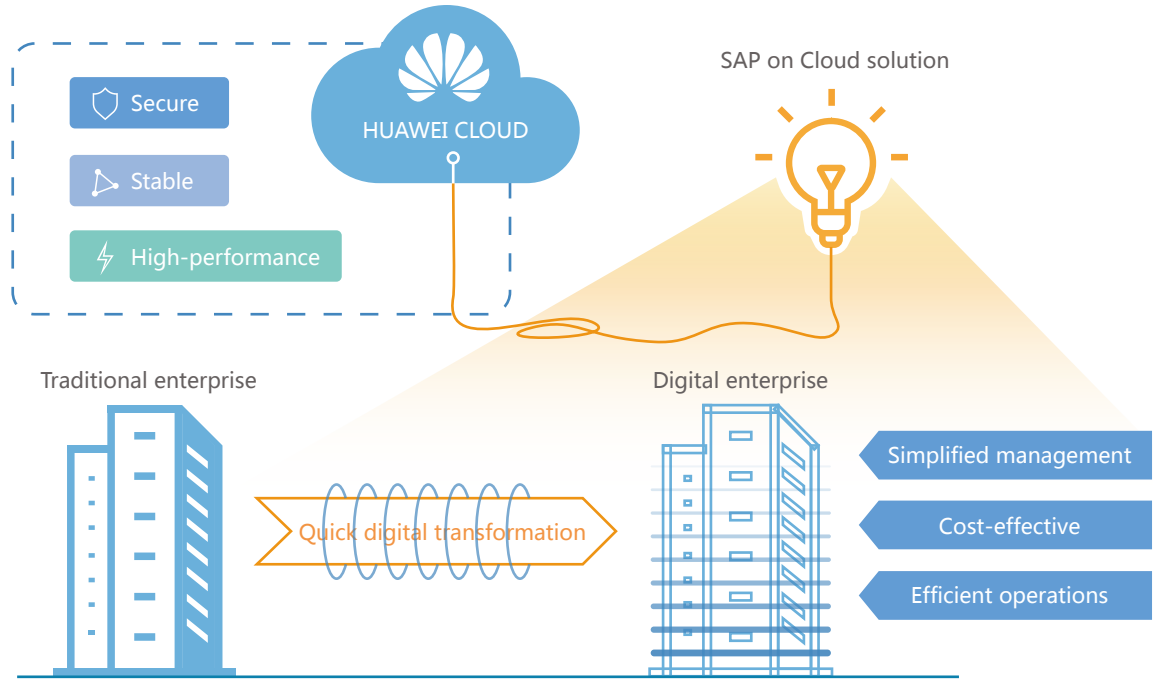

1.2 Why HUAWEI CLOUD

Deploying SAP services on HUAWEI CLOUD leverages its secure, stable, and high-performance infrastructure as well as powerful EI, big data, and lifecycle management services. This helps enterprises overcome the disadvantages of traditional ERP systems, simplify enterprise management, reduce costs, optimize operations, and facilitate digital transformation.



Customers Benefits

 <p>Low TCO</p> <p>The system is plug-and-play and requires no O&M, and the TCO is reduced by over 30% by using pay-as-you-go.</p>	 <p>Flexibility and Efficiency</p> <p>Backup and DR can be implemented with just a few clicks, monitoring data is displayed on a full screen, and application management efficiency is improved by more than 60%.</p>	 <p>Quick Deployment</p> <p>Release time is shortened by more than 30% to the minute level.</p>
 <p>Security and Reliability</p> <p>The entire platform, all nodes, and all services have security certifications.</p>	 <p>Outstanding Performance</p> <p>Performance is improved by more than 20%, and the SAPS value is the highest for its specification.</p>	 <p>Pay-As-You-Go</p> <p>Resources are scaled up and down in minutes, avoiding resource shortage and waste.</p>

Advantages

Various specifications

ECSs with high specifications

Supports 7 types of HANA ECSs with 348 GB to 4 TB of memory, meeting a wide range of enterprises requirements.



BMS service

A BMS with 16 TB of memory is available, and a maximum of 16 BMSs can be deployed in a cluster.

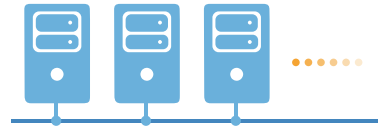

High performance

No. 1 certified performance

Ranks first in the industry in terms of the SAPS benchmark released by SAP.

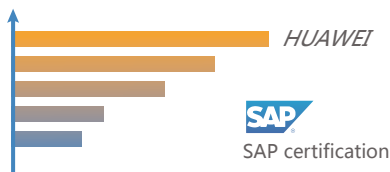

High-performance IaaS

New generation V5 processor. Huawei's proprietary 25GE NIC chip supports hardware offloading, and its network performance is 4 times higher than that of the certification requirements. The performance of the 56 GB IB storage network is 5 times that of certification performance.

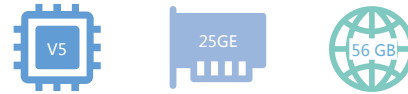

High reliability

High availability

Provides comprehensive HA and DR solutions for HANA and SAP applications. Exclusive storage-based active-active DR reduces costs by more than 70%.



High security

Tier-3 data centers, carrier-level security architecture, and no collection of customer data.



Usability

O&M management

Exclusive SAP management tool improves cloud deployment efficiency and reduces O&M difficulty and cost.

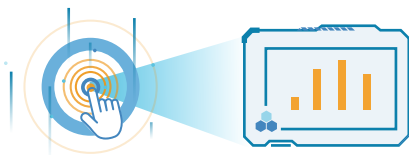

Delivery O&M

Professional SAP-certificated O&M service safeguards enterprises' cloud migration.



1.3 Solution Architecture

The HUAWEI CLOUD SAP on Cloud solution provides one-stop SAP platform services for enterprises, facilitating digital transformation with industry-leading HUAWEI CLOUD IaaS services, EI and big data capabilities, as well as SAP management and O&M services. Regardless of experience with SAP, enterprises can easily use HUAWEI CLOUD's automatic installation and deployment tool and ecosystem partners to quickly build an environment and launch a system.

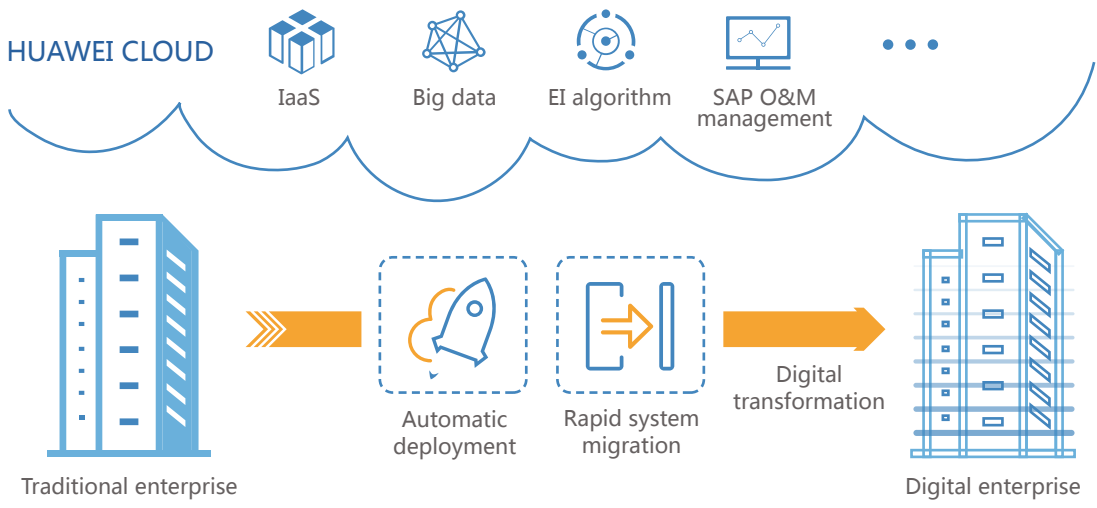

SAP on Cloud Architecture

SAP	S/4HANA	BW/4HANA	Business Suite	SAP Hybris	Business One	
	BusinessObjects	BPC	SAP HANA Express Edition	HANA	PO	
Application services	Automatic deployment	Automatic backup & recovery	Automatic capacity expansion	SAP full-screen monitoring	System cloning & refreshing	
Big data platform	Data extraction	Data modeling	Data governance	AI algorithm library		
Integrated middle ground	Application integration	Data integration	API integration	IoT integration	Cloud integration	
Cloud infrastructure as a service (IaaS)	Computing services	ECS	BMS	IMS		
	Storage services	EVS	OBS	CBR	DES SFS	
	DR service	SDRS				
	Network services	VPC	ELB	VPN	Direct Connect	
	Security services	DBSS	KMS	WAF		
Database	SAP HANA	SAP ASE	ORACLE	Microsoft SQL Server	IBM DB2	

1.4 Application Scenarios

What are enterprises' concerns when migrating SAP to the cloud?

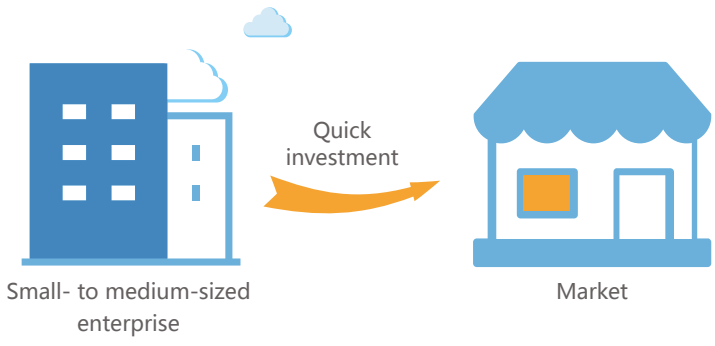

As a small- to medium-sized enterprise, can we migrate our entire SAP system to the cloud?

As a rapidly growing company responding to ever-changing customer requirements, innovation is critical to us. To support innovation, can we run the SAP development and test systems on the cloud?

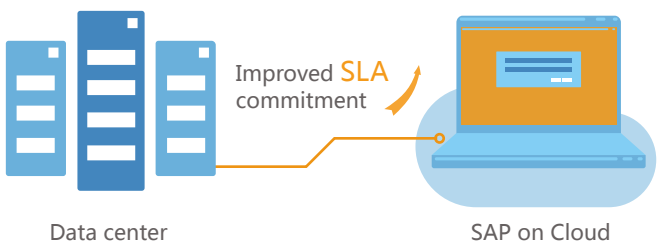
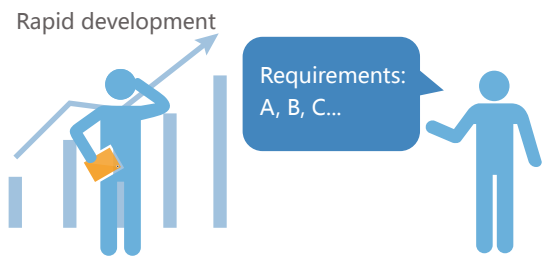

As an enterprise's core system, SAP plays an important role in determining the SLA. DR is a key part of the SLA commitment. Is it possible to quickly build a DR system on the cloud and achieve HA?

As a large enterprise, our long-term infrastructure requirements are concerned around security, performance, reliability, sustainable evolution, and professional O&M. Is there a reliable dedicated cloud to help achieve these goals?

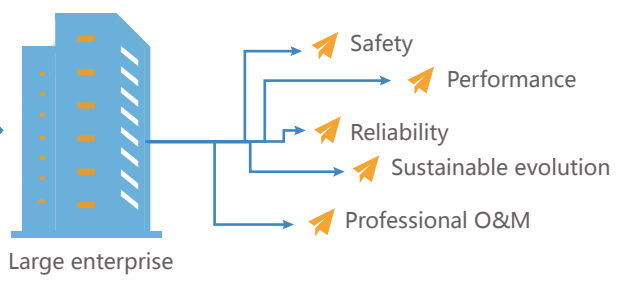

Scenario 1: Entire SAP System on Cloud

Introduction

The entire SAP system is deployed on HUAWEI CLOUD. You can access the SAP system through the IPsec VPN tunnel or Direct Connect to use resources with high specifications, performance, and security. In addition, HUAWEI CLOUD provides intuitive O&M capabilities. Perfect for enterprises that have never deployed an SAP system before, have few O&M personnel, or have uncertain hardware resource requirements

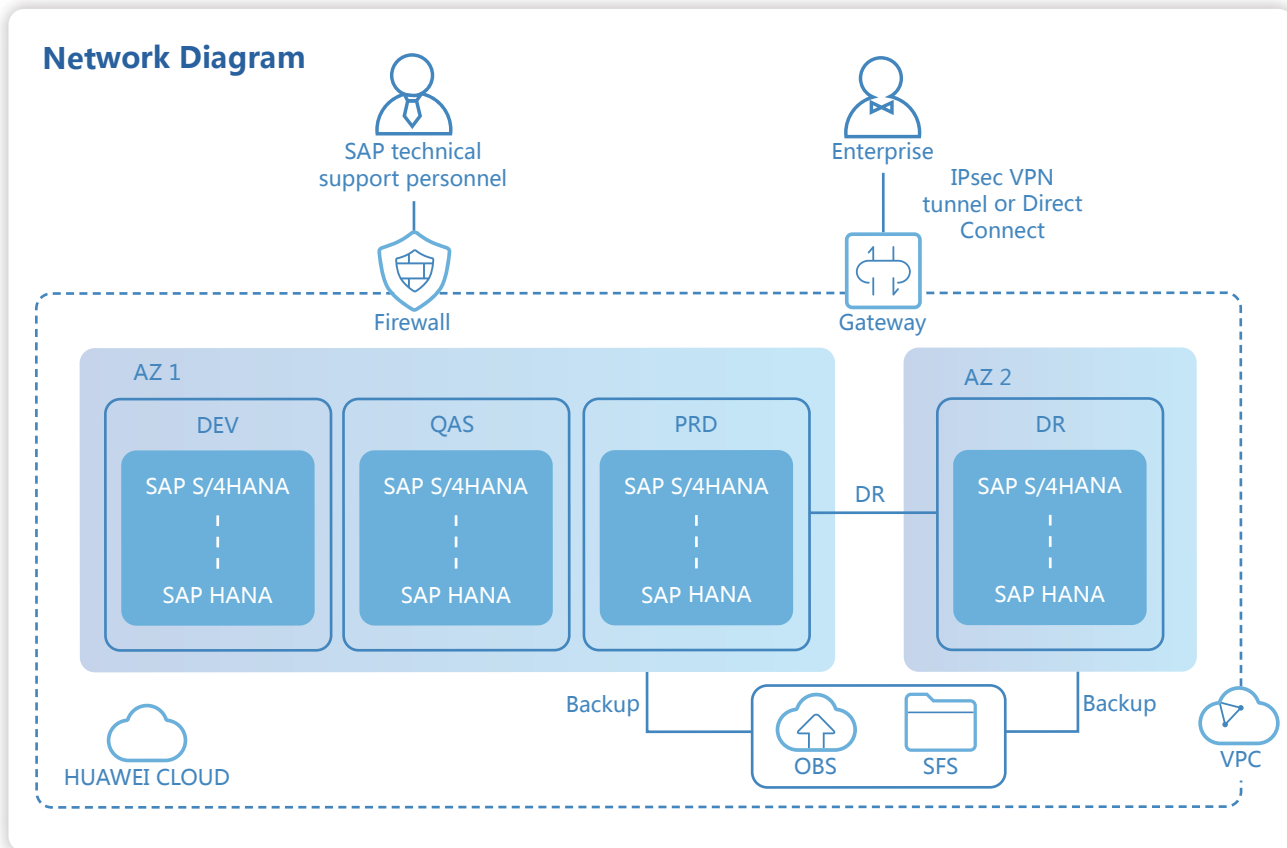

Advantages



On-demand resources, reduced TCO

Pay only for resources you use and avoid upfront costs, reducing the total cost.

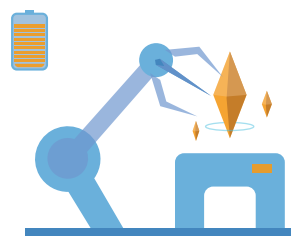

Fast deployment and improved efficiency

Services can be provisioned within minutes and quickly scaled up and down.

Scenario 2: SAP Dev and QAS on Cloud

Introduction

The production system is deployed in your data center, and the development and test systems are deployed on HUAWEI CLOUD. The two on-cloud systems are connected to the production system through the IPsec VPN tunnel or Direct Connect.

Perfect for enterprises that need quick development and need to verify new requirements quickly

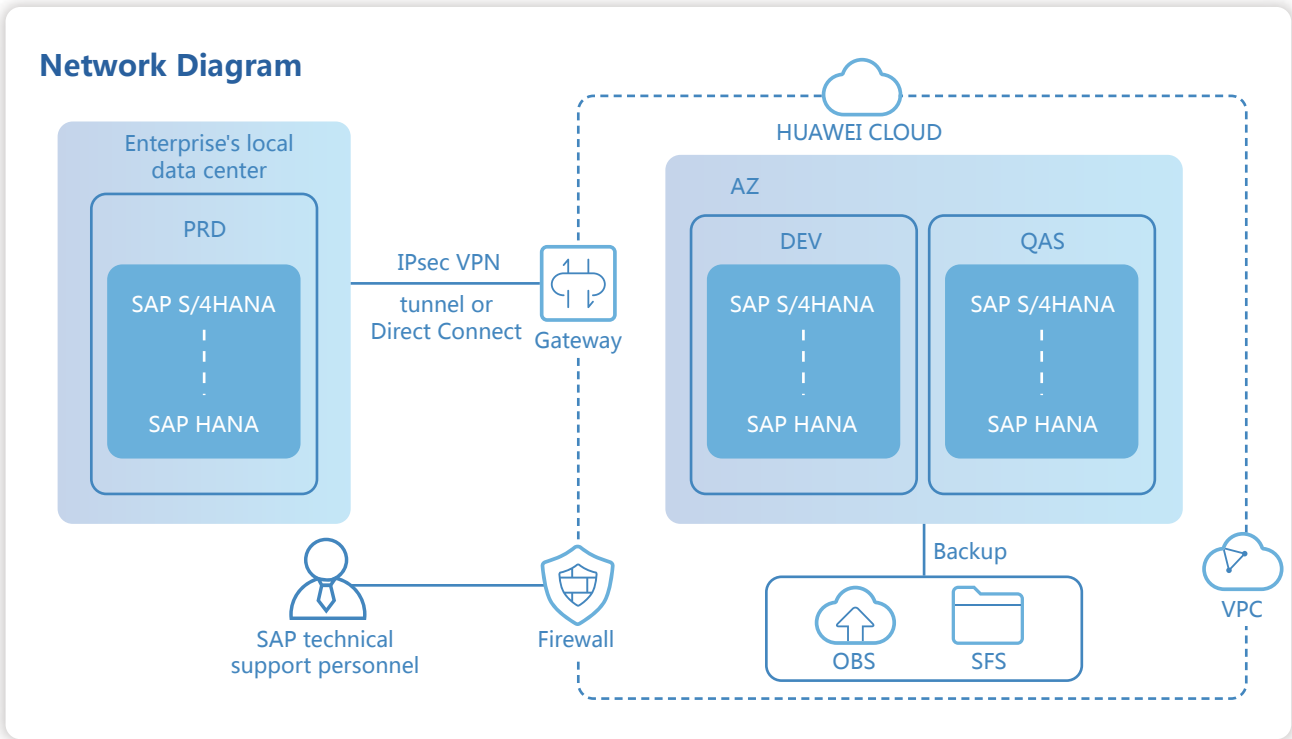

Advantages



Flexible deployment

The production system is deployed in the local data center, whereas the development and test systems are deployed on the cloud. This allows you to make full use of both local resources and on-cloud SAP.

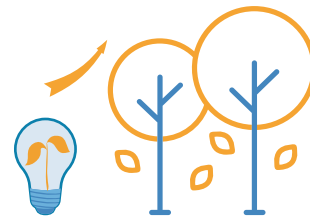

Accelerated innovation

Pay-as-you-go billing reduces the costs and risks of innovation. Applications that are developed and tested on the cloud can be quickly replicated on the production system.

Scenario 3: SAP DR System on Cloud

Introduction

The production system is deployed in your local data center, whereas the DR system is deployed on HUAWEI CLOUD. The SAP HANA system replication function ensures data synchronization, improving system reliability. You can secure your system with minimal investment. Perfect for enterprises whose existing SAP system does not have a DR system due to regional or budget constraints

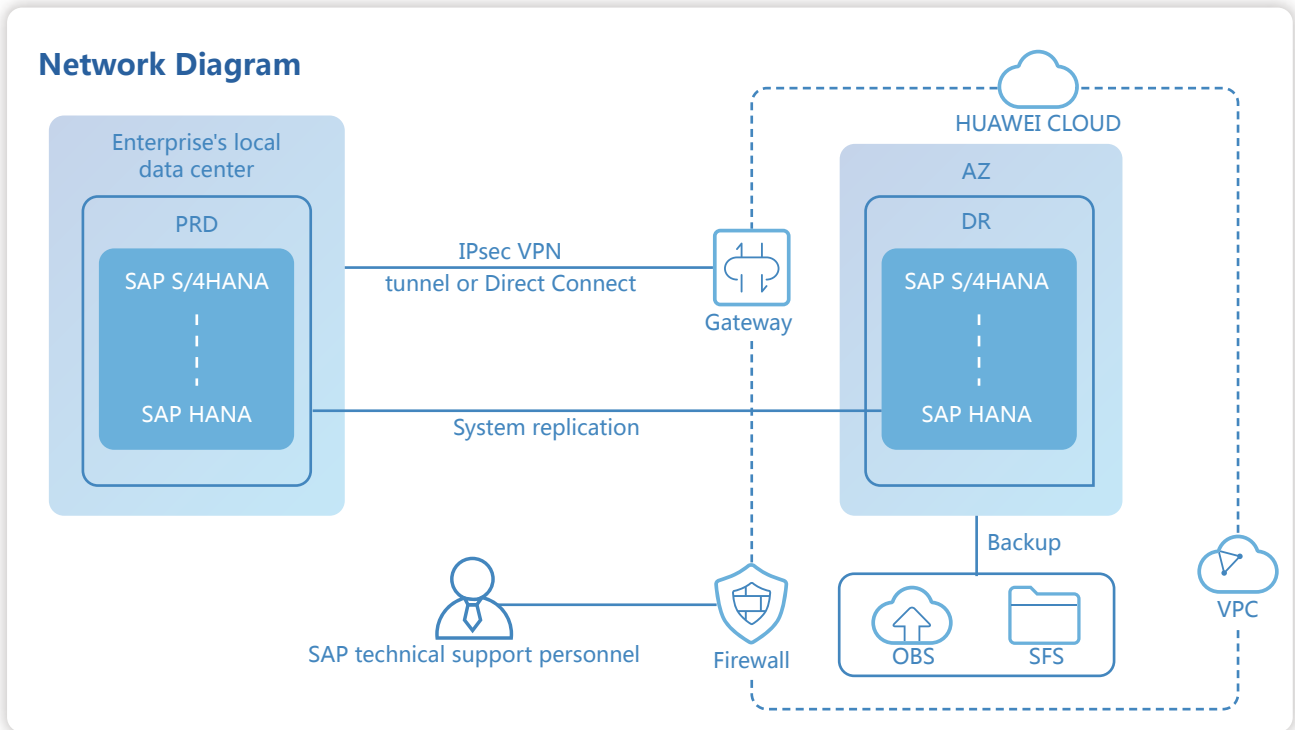

Advantages



Secure and reliable

Transmission encryption and Huawei Tier-3 data centers ensure that cloud resources are secure and reliable. System replication ensures there is no loss of data.

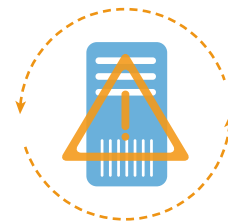

High resource utilization

You can disable system replication and deploy the development and testing HANA database on the standby node so that it works when the production system is running normally. If a fault occurs, the development and testing database is stopped, and the standby node takes over. This improves the utilization of the standby node's resources.

Scenario 4: SAP on DeC

Introduction

You can apply for dedicated physical devices and regions with computing, storage, and network resources. This ensures data security and service stability. Perfect for medium- and large-sized enterprises that have high data security requirements

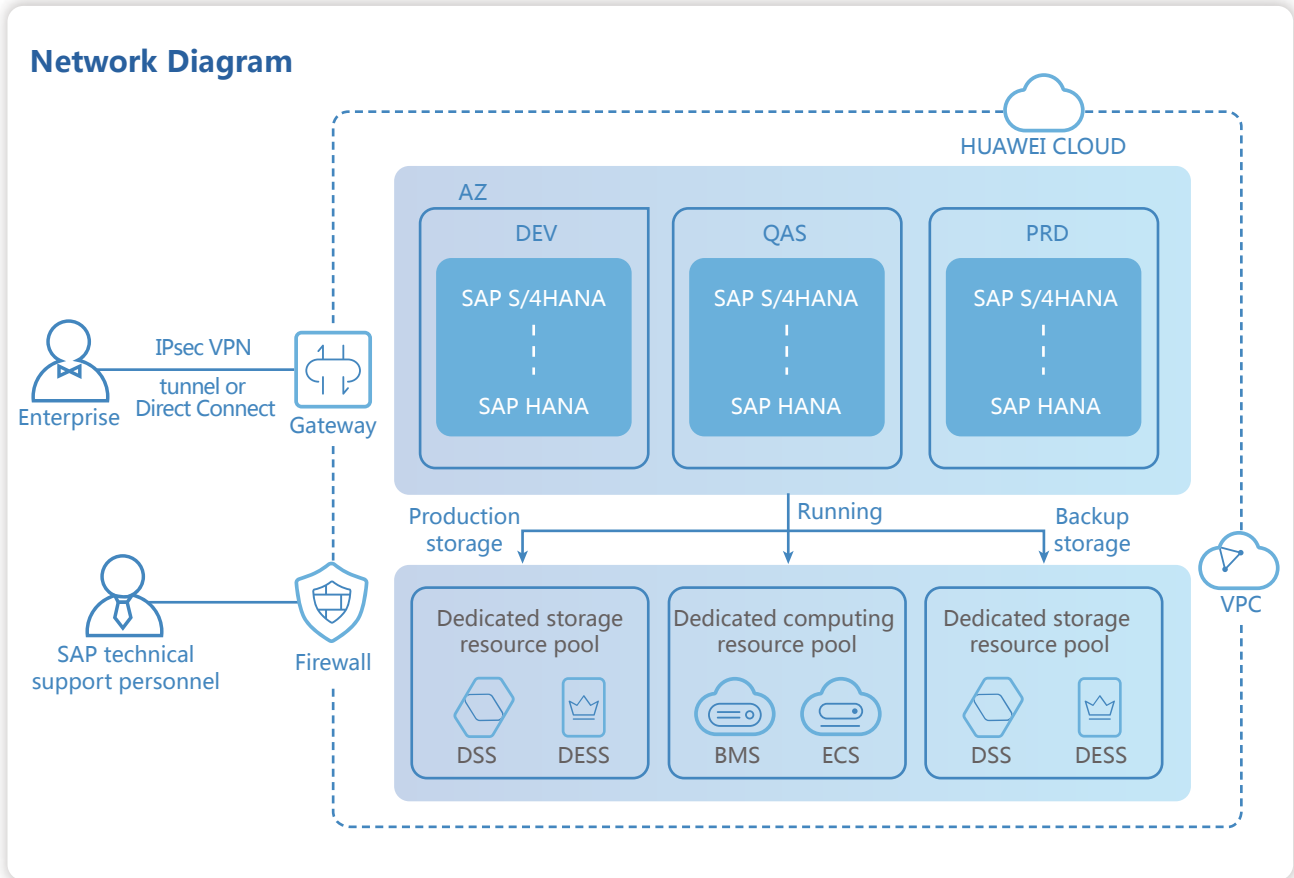

Advantages



Customized security

Features physical isolation, Layer 2 network isolation, dedicated physical resources, and stored data encryption, providing customized security services.



Excellent performance

Supports high-performance bare metal services and dedicated enterprise storage, enabling your systems to run smoothly.

1.5 Feature Tree

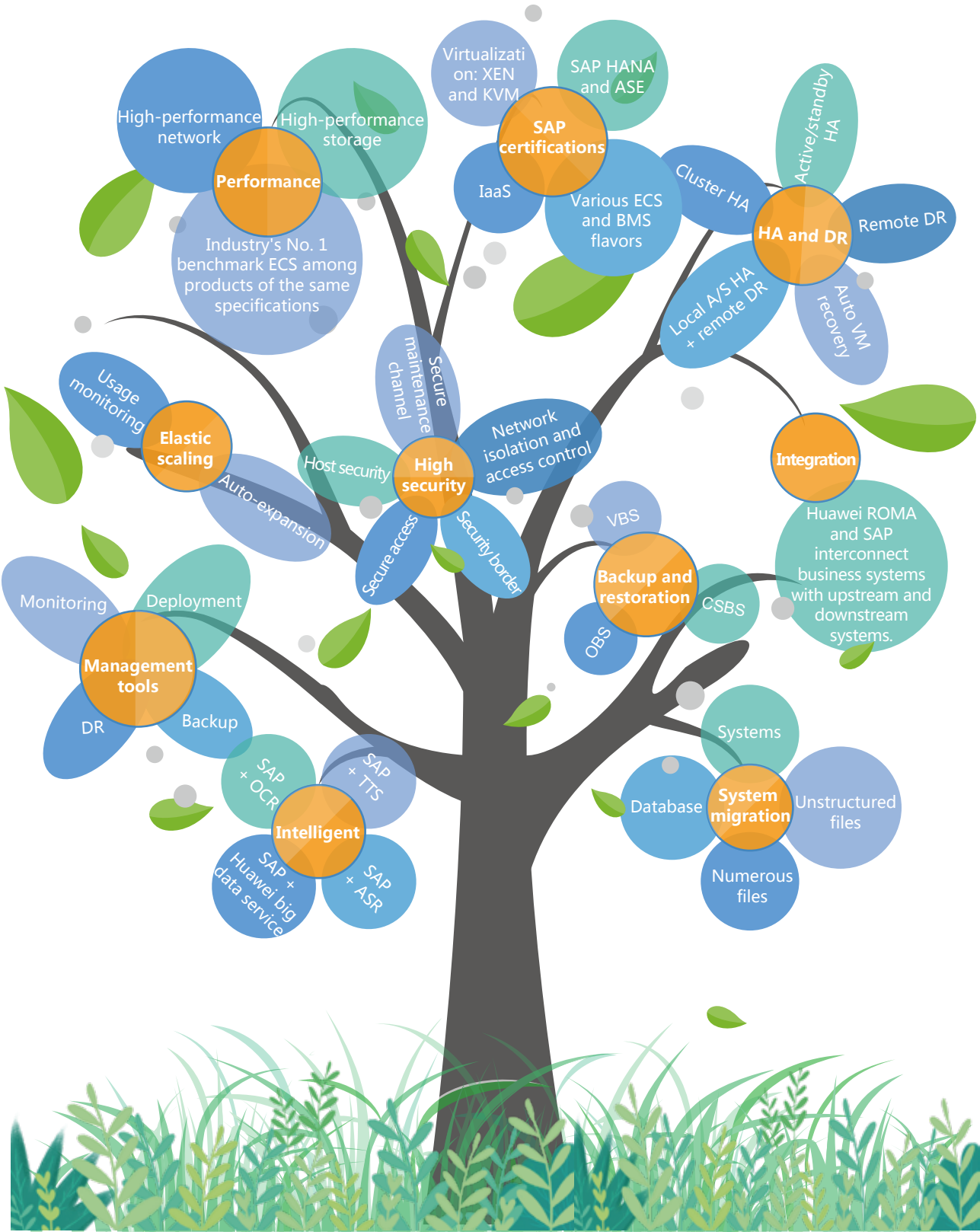

2.1 SAP Certifications

Background

An SAP-certified public cloud vendor provides an IaaS platform to install, run, and manage SAP software.

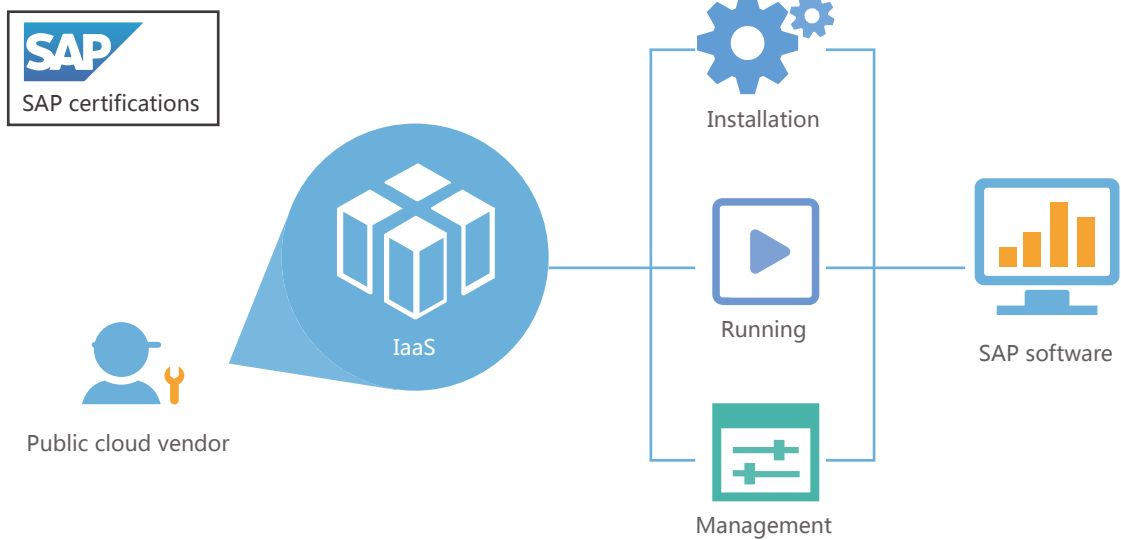

Features

Huawei and SAP have worked closely since partnering in 2012. Huawei has many certifications for servers, virtualization, SAP HANA, SAP ASE, SAP NetWeaver Application Server with ABAP and Java, SAP Business One, and SAP Operation & Hosting. More offerings will be certificated in the future.

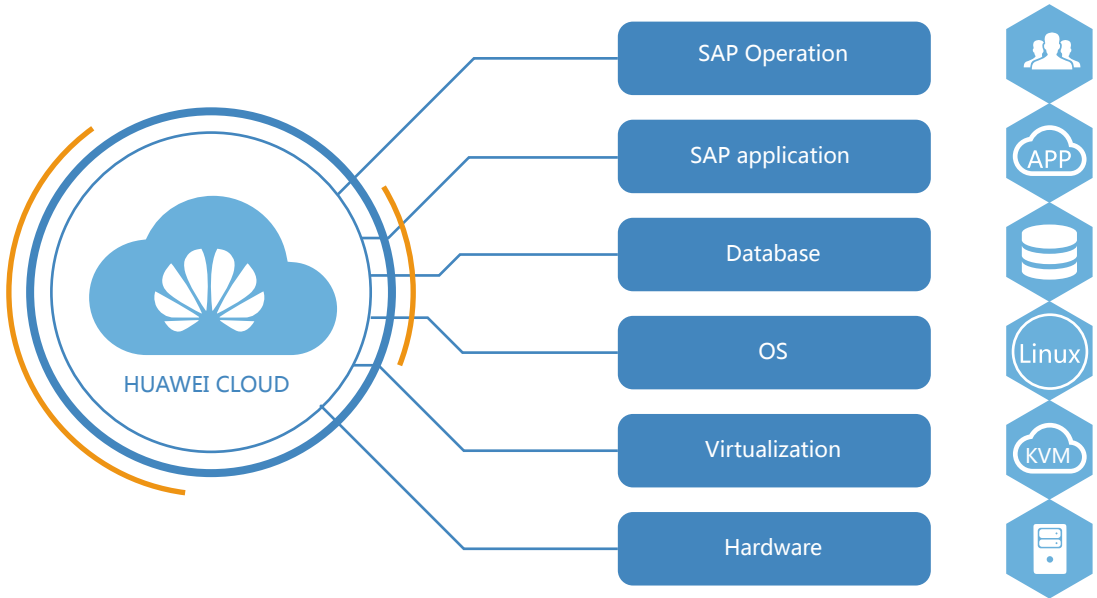

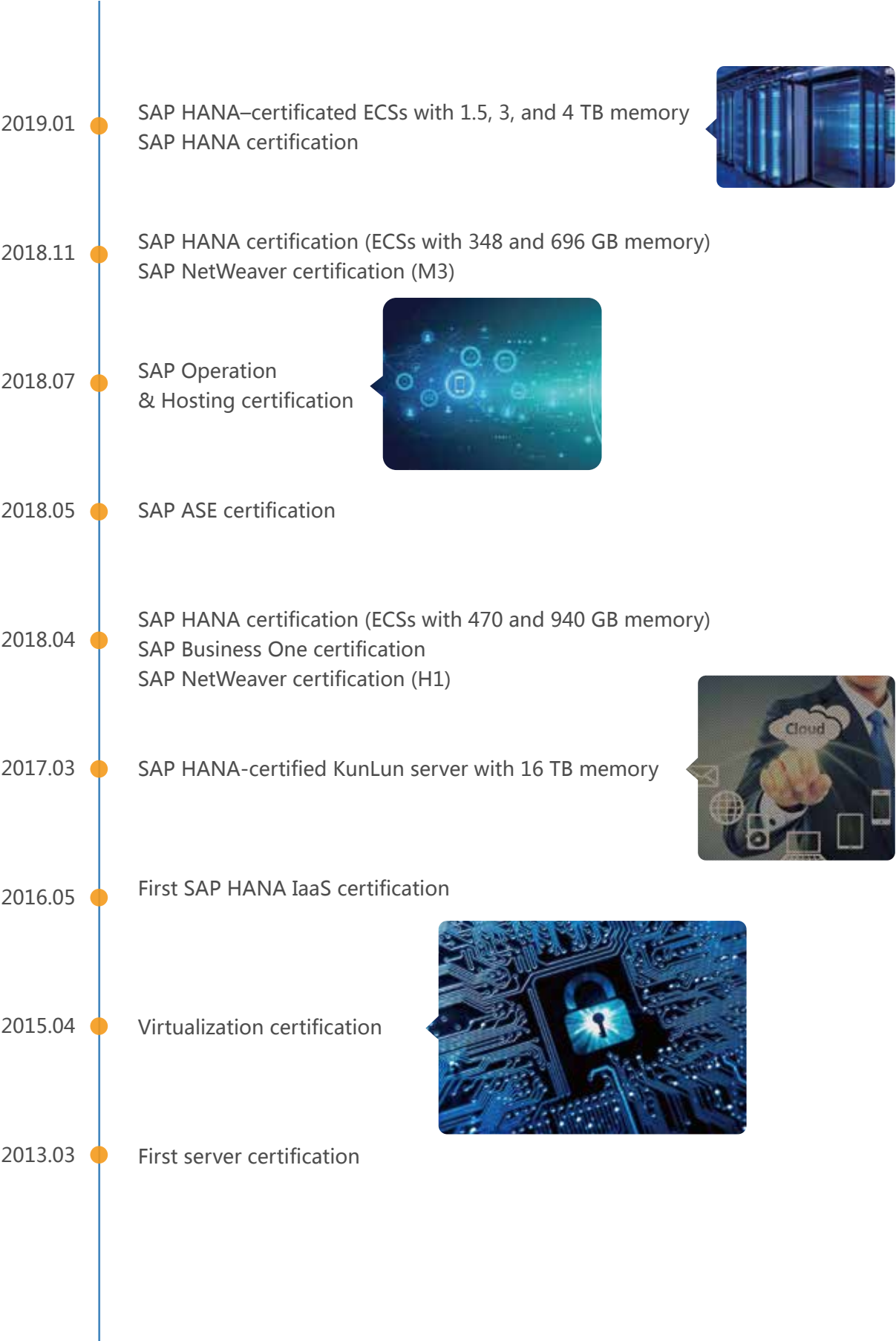

2.2 Performance

Background

Before deploying the SAP system at the IaaS layer, plan the resources based on enterprise SAP system requirements. Storage IOPS, VM instance SAPS, and network interfaces are important aspects of resource planning.

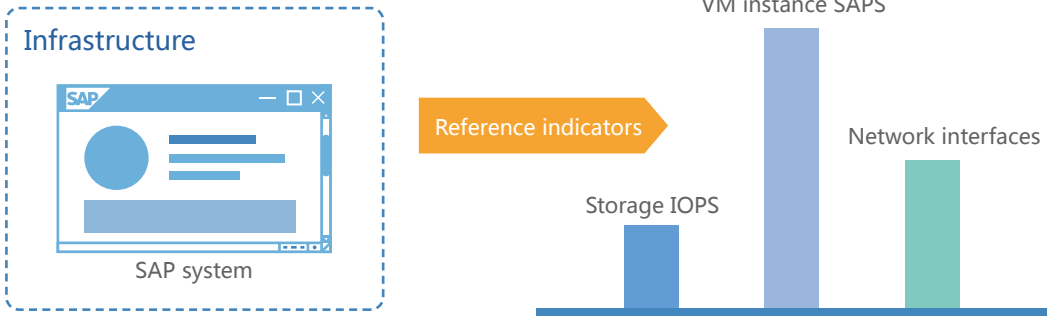

Features

Industry-leading SAP official benchmark SAPS

The SAP Xeon V5 m3 ECSs support up to 32 vCPUs and 256 GB of memory. The SAPS value ranked No. 1 among products of the same specifications. SAP HANA-certificated Xeon V5 ECSs (1.5 and 3 TB of memory) have excellent BWH performance.

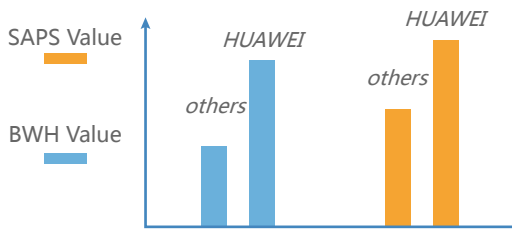

High-performance network

Huawei 25GE network chips support hardware offloading. The chip performance is 4 times the requirements.

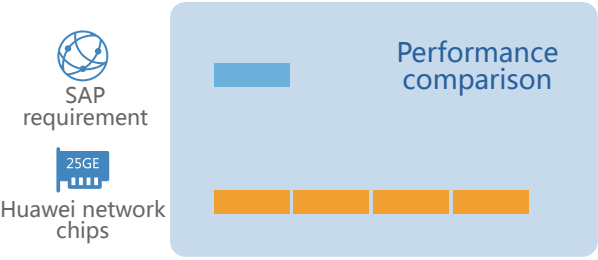

High-performance storage

HUAWEI CLOUD storage KPI values are 2 to 4 times higher than those required by SAP.

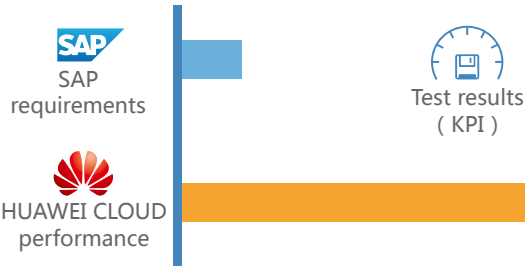

BWH refers to SAP BW edition for SAP HANA benchmark. The SAP Application Performance Standard (SAPS) is a hardware-independent measurement unit describing the performance of a system configuration in the SAP environment. Holding CPUs and memory size constant, a higher SAPS value indicates better performance.

2.3 HA and DR

Background

HA refers to a reliability design aimed at eliminating single points of failures and ensuring system continuity.

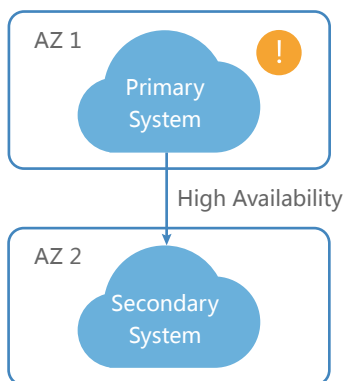

DR refers to the use of a remote backup system that can quickly take over services from a failed local data center. This also ensures service continuity.

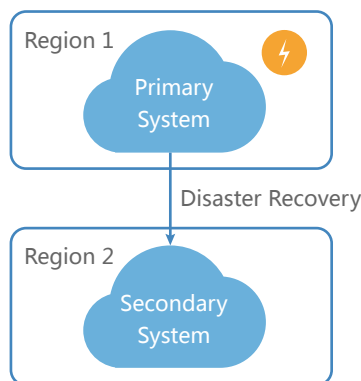

Features

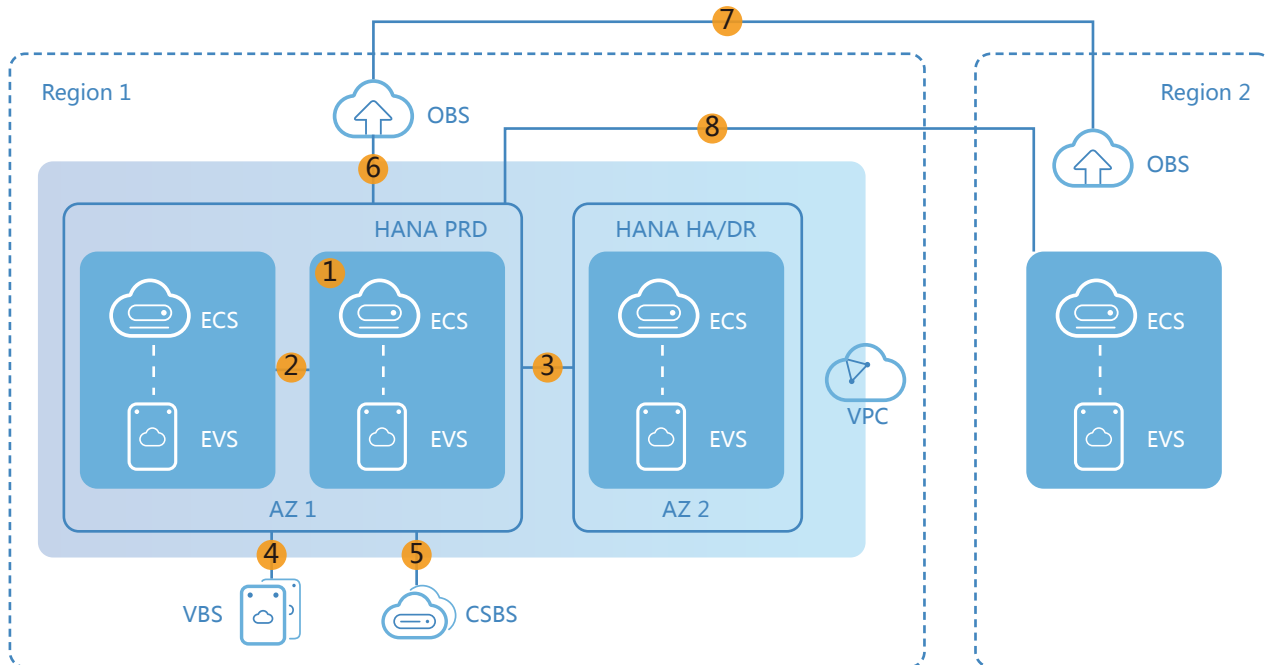

HA

- 1 Automatic ECS recovery
- 2 Intra-AZ Synchronized System Replication
- 3 Cross-AZ Synchronized System Replication

DR

- 4 VBS
- 5 CSBS
- 6 OBS (local)
- 7 OBS (remote)
- 8 Asynchronous System Replication

2.4 High Security

Background



Easy intrusion of service systems



Difficulty ensuring data protection



High security investment

Features

The security solution ensures sound system operations and improves security maintenance. This HUAWEI CLOUD security solution is especially useful for those managing a distributed system environment, enhancing security control over the SAP system.



Channel Security

You can connect to HUAWEI CLOUD through Direct Connect or a VPN, and deploy the virtual next-gen firewall (NGFW) to protect SAProuter, ensuring the security of the SAP Support channel.



Intranet Traffic Control

Security groups and network ACLs allow you to control intranet accesses of the SAP system, and the virtual NGFW helps you monitor intranet traffic security.



Key Management

The key management service offers secure, reliable, and easy-to-use management, integrates multiple basic cloud services, and securely stores SAP system data.



Vulnerability Discovery

The Vulnerability Scan Service quickly uncovers SAP system vulnerabilities in real time. The Security Assessment Service offers comprehensive, in-depth, and professional security assessments on your SAP system.



O&M Management

Bastion hosts and security groups ensure access server security and meet the Classified Cybersecurity Protection Class 4 requirements, including user identity authentication, access control, and security audits.

2.5 Backup and Restoration

Background

To ensure data reliability, periodically back up SAP HANA data.

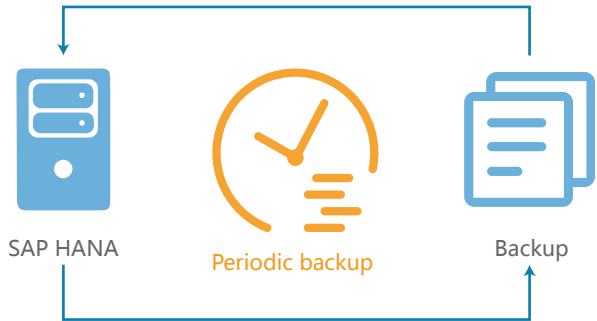

Features

HUAWEI CLOUD OBS, VBS, and CSBS, as well as the backup function provided by SAP or a third-party backup tool, effectively back up SAP service data running on HUAWEI CLOUD. This backup can be used to restore SAP services.

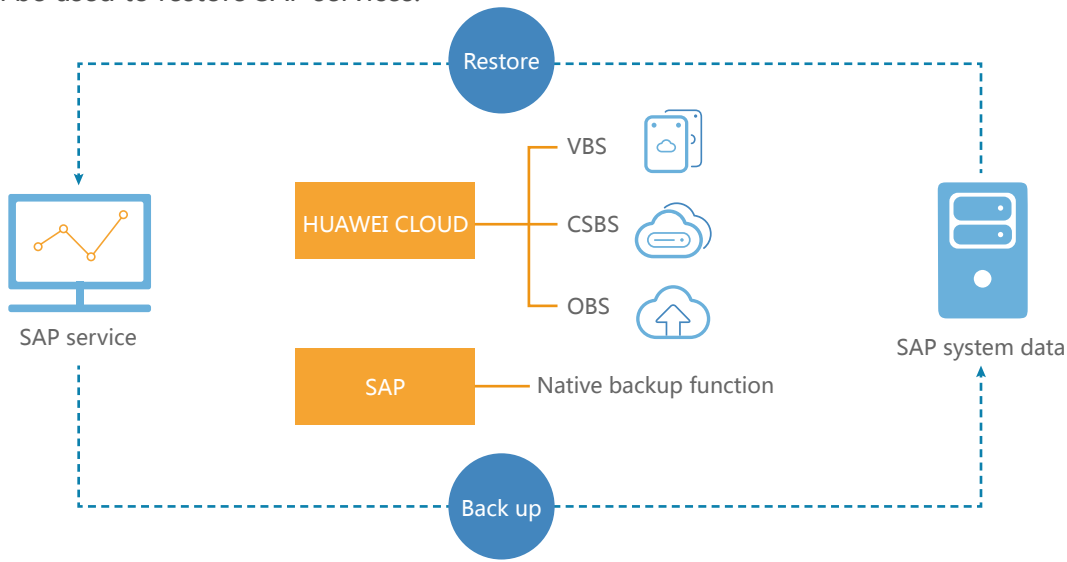

Category	Description	Scenarios	Backup Method
File system backup	You can back up a single file or directory. Triggered from application servers, data consistency between applications and databases is ensured.	All	SAP Studio, SAP HANA Cockpit, and third-party tools, such as NetBackup
Storage volume backup	Backup based on storage is transparent to applications and databases. Therefore, data cannot be consistent between applications and databases.	Stateless applications and SAP development and test environment	Use the VBS service to back up data based on a single volume. Use the CSBS service to back up data based on a VM.

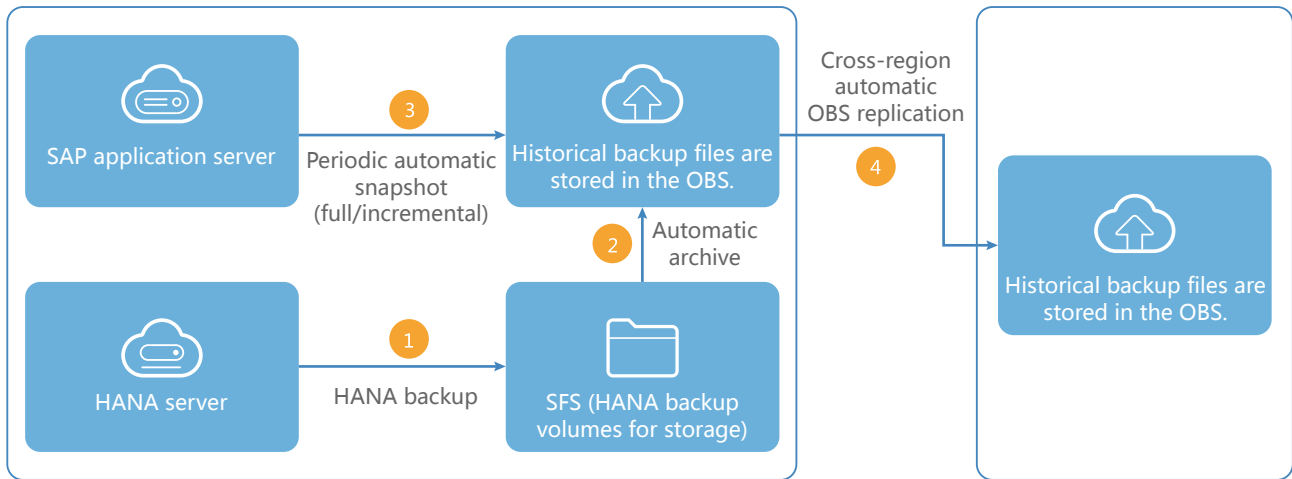

Backup process:

1. HANA database is backed up to SFS through HANA Studio.
2. HANA backup files are periodically archived from SFS to OBS (Huawei provides automatic archiving scripts).
3. SAP applications use the VBS or CSBS backup function to periodically back up data to OBS.
4. Cross-region OBS replication is used to store backup data to the remote OBS for cross-region DR.

2.6 SAP Management Tool

Background

Traditional data center management tools cannot meet the O&M requirements of cloud services. Maintaining and monitoring applications on the cloud is challenging, and enterprises need new management tools for cloud-based SAP O&M.

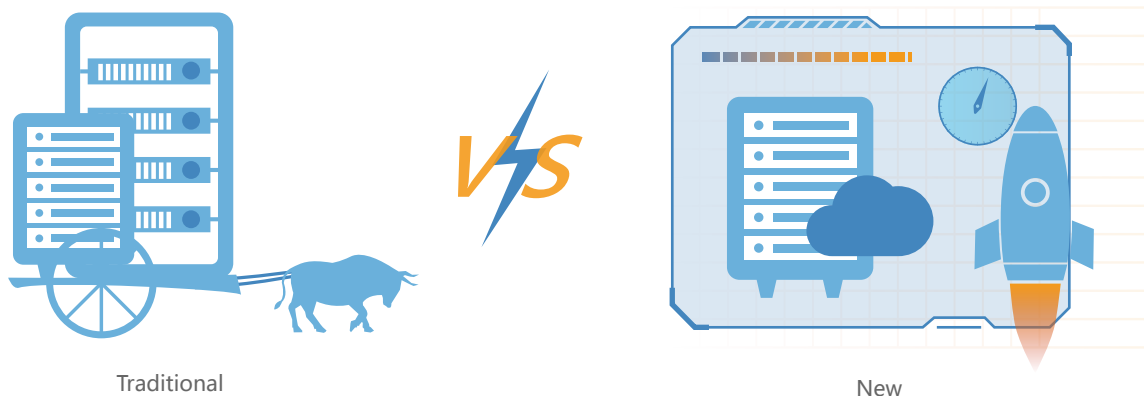

Features

HUAWEI CLOUD Enterprise Project Management Service (EPS) allows you to manage resources, applications, and O&M tasks, and provides monitoring alarms. You can use it to orchestrate resources, deploy software, back up and restore data, and recover applications after disasters. It is the best one-stop management choice for SAP applications.

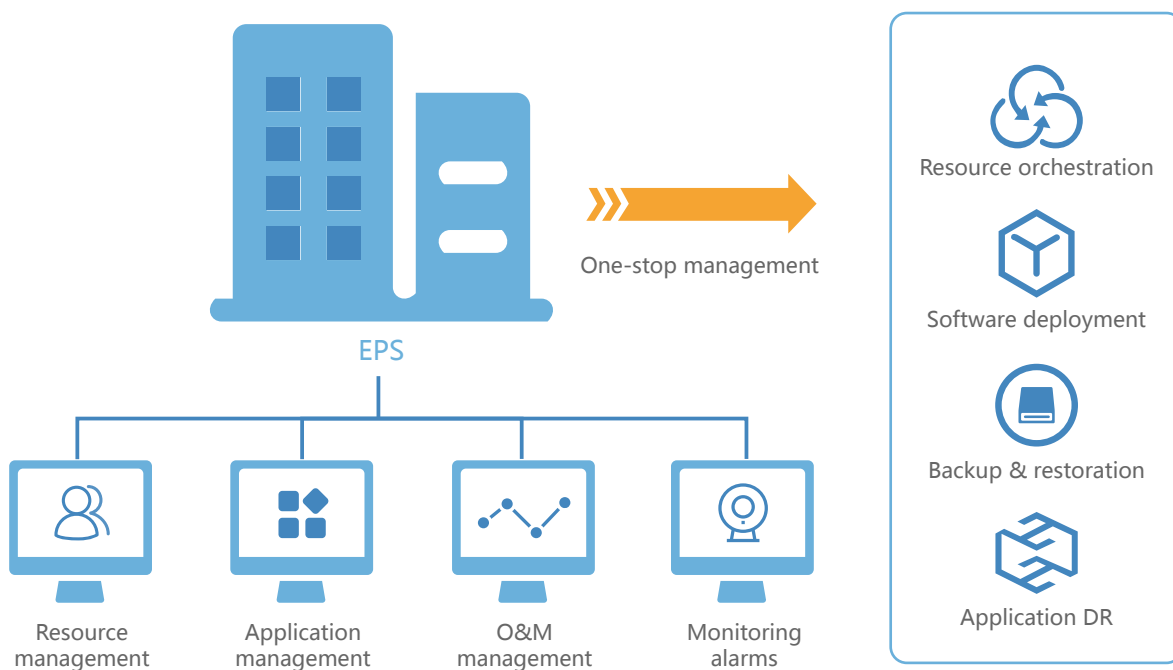

2.7 Elastic Application Scaling

Background

Elastic SAP application scaling automatically increases the number of additional application servers (AASs) according to SAP service requirements. You can specify AS configurations and policies based on service requirements. These eliminate the need to repeatedly adjust resources in response to service changes and demand spikes, reducing your workload and resource requirements.

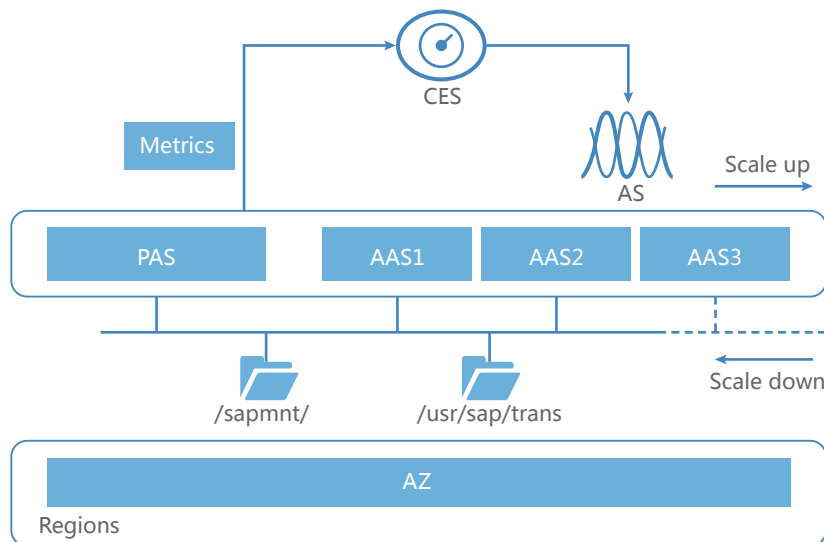

Features

You can configure the primary application server (PAS) and AASs in the same AS group, and AS policies based on alarm policies. You can set alarms to be triggered at CPU usage thresholds. When a monitored metric reaches its threshold, instances are automatically added in silent installation mode to ensure proper service running. The cluster can be repaired in the following scenarios:



Automatically Adding an AAS

When services increase, AASs are automatically added to ensure services run normally, optimizing the cost management of application systems.



Manually Adding an AAS

If services are temporarily adjusted, manually create AASs to ensure normal service running.

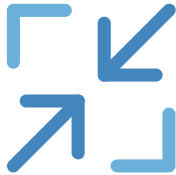

Manually Releasing AASs

After service pressure decreases, no running process exists in the AAS. To reduce resource waste, you can delete the AAS.

2.8 Integration

Background

The hybrid cloud integration platform supports both cloud and off-cloud applications for SAP system cloud migration. The system can securely interconnect with other systems across networks and data centers. Cloud SAP systems, non-SAP applications, and third-party SaaS are integrated. On a single or hybrid cloud, the platform supports cloud applications, local applications, master data, IoT, and cross-network B2B integration.

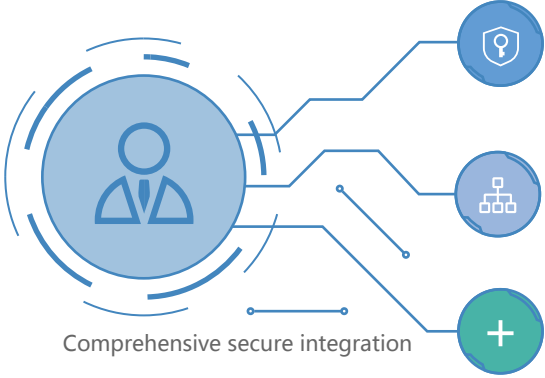

Features

Various interconnections

To streamline cloud migration, SAP cloud applications are integrated with applications, processes, APIs, data, IoT, and cloud services.

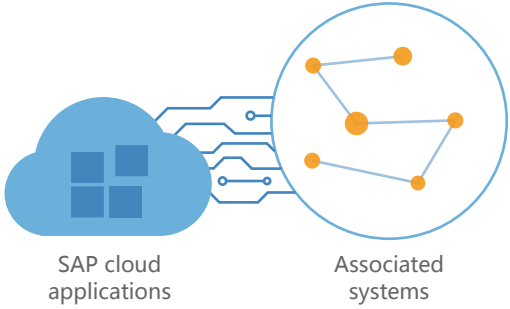

On- and off-cloud integration

On-cloud businesses and applications can communicate with off-cloud counterparts through a platform that securely integrates SAP cloud systems with intranet applications and B2B systems on external networks.

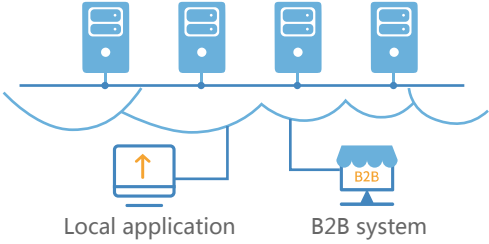

Cross-region integration

Applications are deployed in a distributed way and integrated across data centers to reduce latency caused by cross-region integration, ensuring efficient service running.

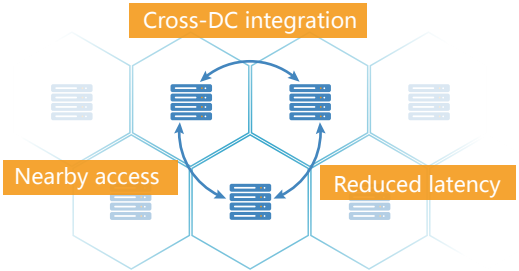

IT/OT convergence

Driven by IoT and EI technologies, the integration of IT and OT systems facilitates service innovation and interconnection among devices.

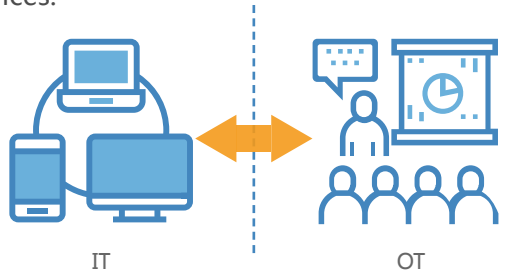

Huawei experience

Huawei uses the ROMA platform to facilitate enterprise digital transformations. The platform integrates business application data 2 to 4 billion times a day in various scenarios. More than 600 IT systems and 20,000 integration points in 170 countries and eight regions are connected, and the platform integrates hundreds of SaaS and cloud services. Huawei collaborates with 100 ecosystem partners worldwide to integrate campus, manufacturing, and IoT data.

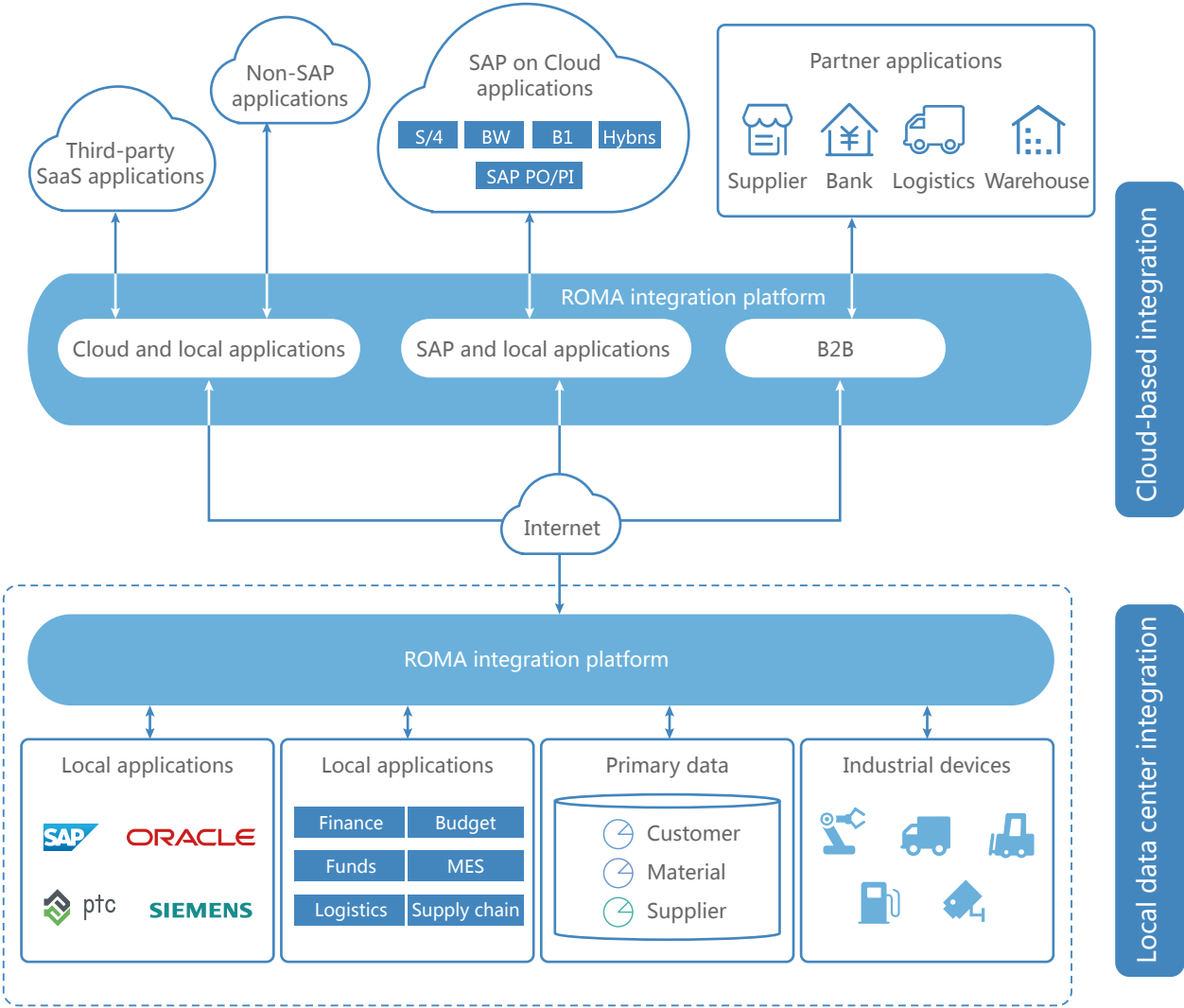

3 Success Stories

HUAWEI CLOUD SAP on Cloud Helps Universe Filter Become a Dynamic Enterprise

SAP S/4HANA | Entire SAP System on Cloud | New Implementation

We at Universe Filter were focused on traditional manufacturing, but decided to digitally transform. We sought to collaborate with Huawei in terms of SAP, MES, PLM, and HR management. We found Huawei's reliable and stable infrastructure and professional O&M services for SAP attractive, especially compared to off-cloud self-built data center options. HUAWEI CLOUD helped us roll out systems faster and reduce our O&M workload. We hope to continue working with Huawei in the SAP on cloud field.

— Ben, Universe Filter CIO

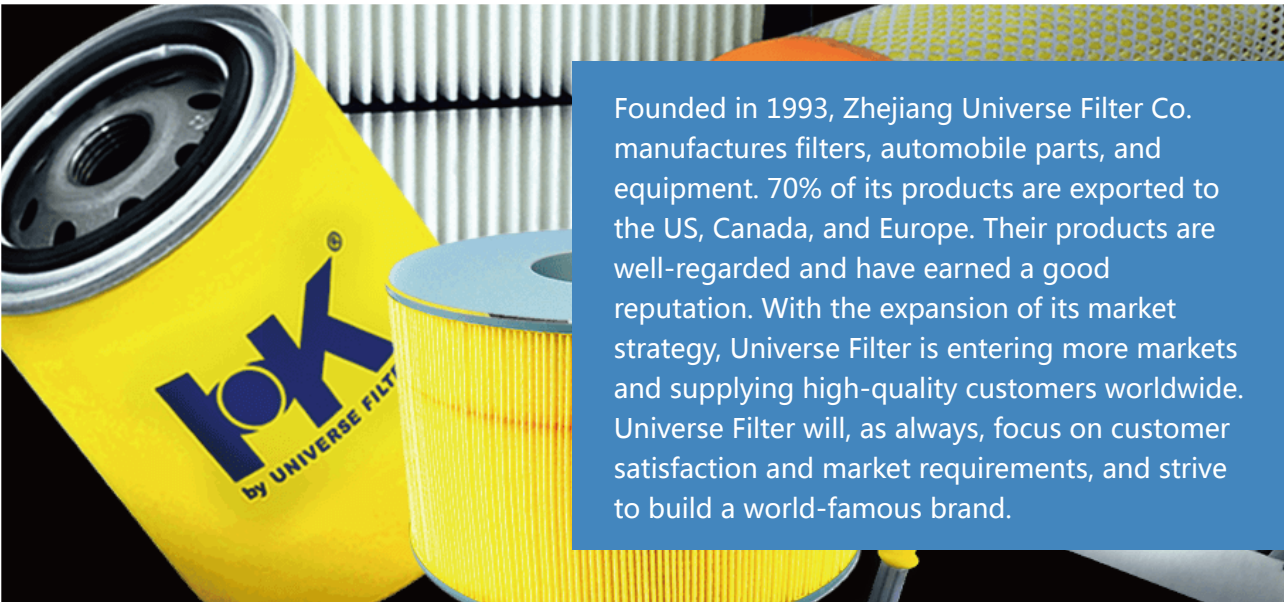

Challenges

Difficult Information Synergy

In order to collaborate with key customers, Universe Filter has migrated part of their production capacity to the global market. The company needed a management strategy suitable for enterprise purchasing and cost control, while also being able to share information between supply chains and commercial partners.



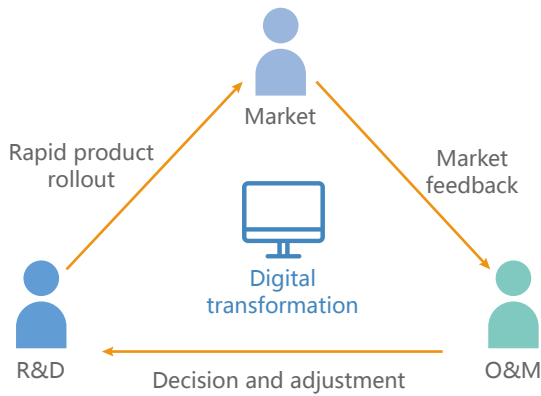

Rapid Innovation

With digital transformation, Universe Filter hopes to accelerate product R&D and project rollout, reduce fixed IT costs and O&M personnel, and adjust its product lines according to market feedback.

Digital Transformation

With SAP S/4HANA on HUAWEI CLOUD, Huawei helps Universe Filter build a convenient and efficient real-time data management platform. The platform provides an informatization process for digital transformation of supply chains, decision-making, and analysis of massive financial data, helping Universe Filter digitally transform for the future.

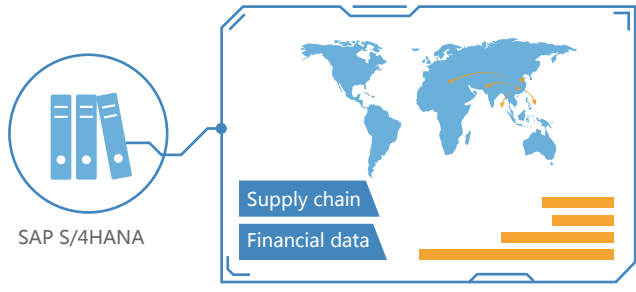

Real-time data management platform

Why HUAWEI CLOUD SAP?

SAP has high cloud platform requirements, and Universe Filter hoped to find an SAP-certified cloud service provider that meets system requirements and provides stable and reliable cloud services. After comprehensively comparing cloud service providers in China, including TCO analysis and POC testing, the company selected HUAWEI CLOUD SAP on Cloud solution.

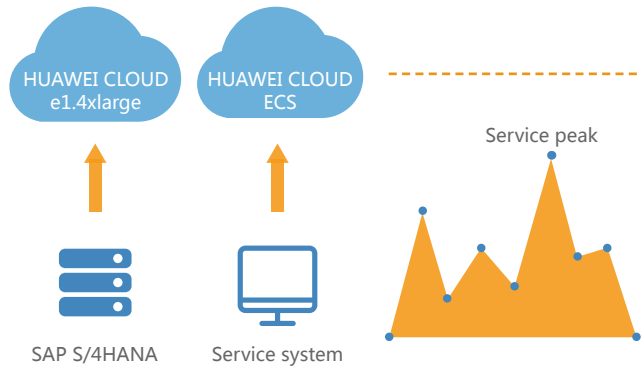

Optimal Performance

SAP S/4HANA is deployed on HUAWEI CLOUD. SAP HANA databases use large-memory ECSs (e1.4xlarge) on HUAWEI CLOUD while service systems use general computing ECSs, ensuring that service systems and databases run stably and efficiently. In addition, HUAWEI CLOUD ECSs can be scaled up or out to ensure to easily cope with service peaks.

Secure and Reliable

After enterprises deploy their IT systems on the cloud, their core service data is on the cloud, and ensuring its security and reliability becomes vital. To ensure the security of customer service systems, HUAWEI CLOUD provides multiple security measures, such as access control, network isolation, key management, and backup and recovery.

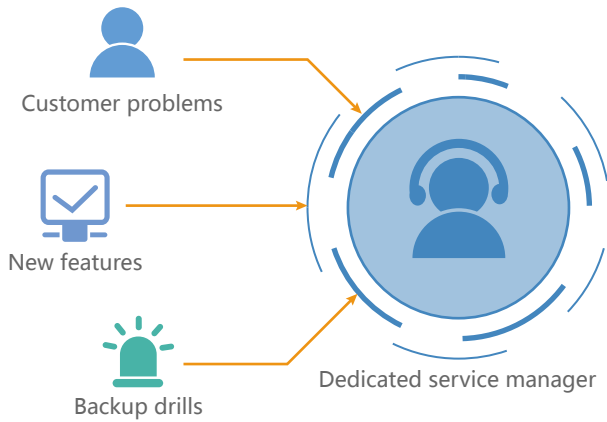
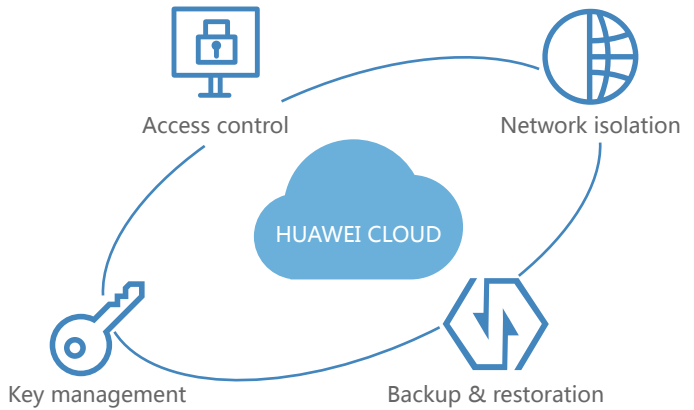

Dedicated Support

The HUAWEI CLOUD SAP on Cloud solution provides Universe Filter with dedicated service managers that quickly respond to customer issues and help customers in terms of new feature rollout and backup drills.

Customer Benefits

With HUAWEI CLOUD SAP on Cloud solution, the SAP S/4HANA system can be quickly brought online. This provides Universe Filter with efficient supply chain management, intelligent logistics, and customer management, ensuring quick and efficient product delivery worldwide. Benefits generated by deploying S/4HANA on HUAWEI CLOUD:

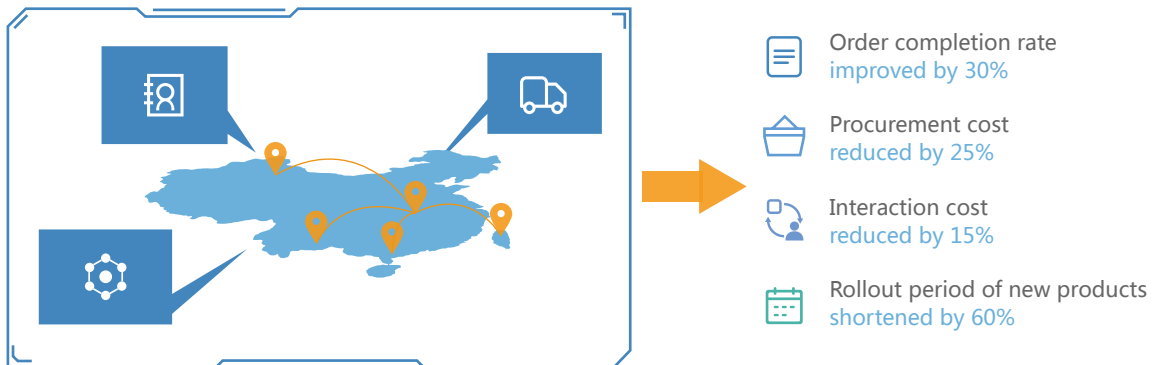

BESTORE Uses HUAWEI CLOUD SAP on Cloud Solution to Build an Industry Benchmark

ECC on HANA & Hybris | SAP Development and Test System on Cloud | Migration to the Cloud

BESTORE is very prudent in choosing its service providers. We chose Huawei for its customer-centric service philosophy and ability to quickly respond to our requirements. BESTORE deployed SAP systems on HUAWEI CLOUD. We find that Huawei's hybrid cloud solution truly helps us meet stringent business requirements and prepare for the future.

— Zhu Shuxiang, CIO of BESTORE



Challenges

As a leader in the Chinese snack industry, BESTORE has developed rapidly, actively integrating Internet technology into its operations. It focuses on innovative ideas such as omni-channel sales, O2O, and new media. During major festivals and holidays, customer orders surge, exceeding 6 million in a day in 2018.



How to ensure stable running of the system and bring ultimate shopping experience to consumers on major holidays.

How to break the barriers between online and offline stores and build an omni-channel intelligent retail management platform to provide consumers with a consistent shopping experience.



Integrated management platform



BESTORE emphasizes innovative development and wants to diversify its retail business to meet future requirements for flexible configuration. How to quickly bring new products to market and actively respond to ever-changing retail demands.

Why HUAWEI CLOUD SAP?

On- and off-cloud integration

Both Huawei private and public clouds use Huawei FusionSphere 6.3, the same APIs, and the unified management software ManageOne, realizing unified management and seamless connection. When off-cloud resources are insufficient, resources can be automatically expanded on HUAWEI CLOUD. In addition, HUAWEI CLOUD resources can be scaled up or out to easily cope with BESTORE's service peaks.

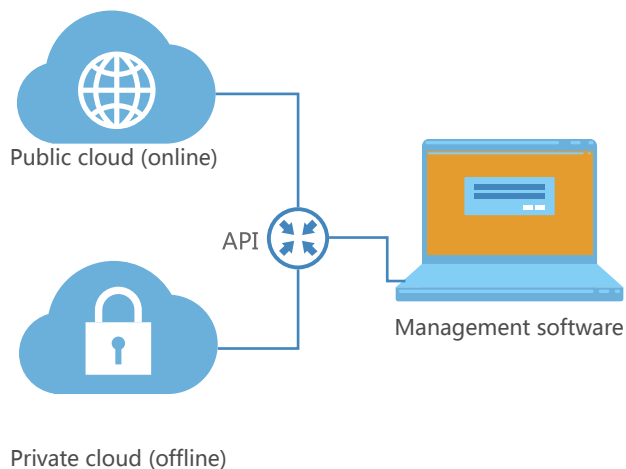

Fast migration

HUAWEI CLOUD provides end-to-end services for migrating off-cloud SAP systems to the cloud. Using Huawei's SMT (a migration tool), more than 30 SAP systems of BESTORE can be migrated to the cloud within three days, and services are interrupted for less than 20 hours.

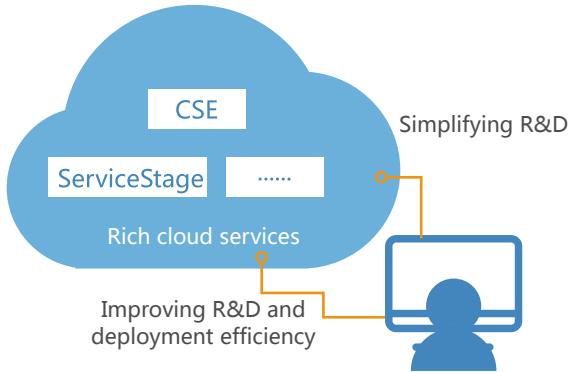
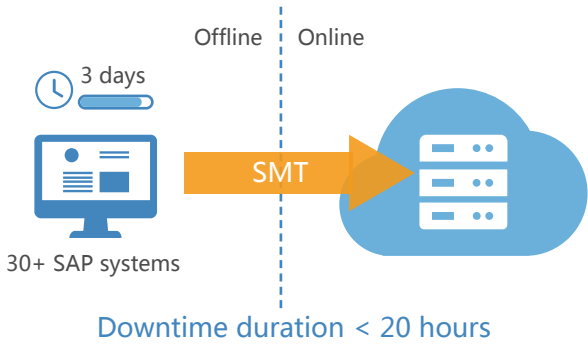

Accelerated innovation

HUAWEI CLOUD provides rich cloud services, greatly reducing application development difficulties and improving development and deployment efficiency. Currently, BESTORE's IT department has over 150 personnel, of which 100 are responsible for system function development. HUAWEI CLOUD PaaS services, such as the microservice engine Cloud Service Engine (CSE) and microservice cloud application platform ServiceStage, can reuse service code, simplify R&D, and accelerate overall efficiency.

Customer Benefits

Huawei's hybrid cloud SAP solution helped BESTORE build an all-channel integrated smart retail management platform.

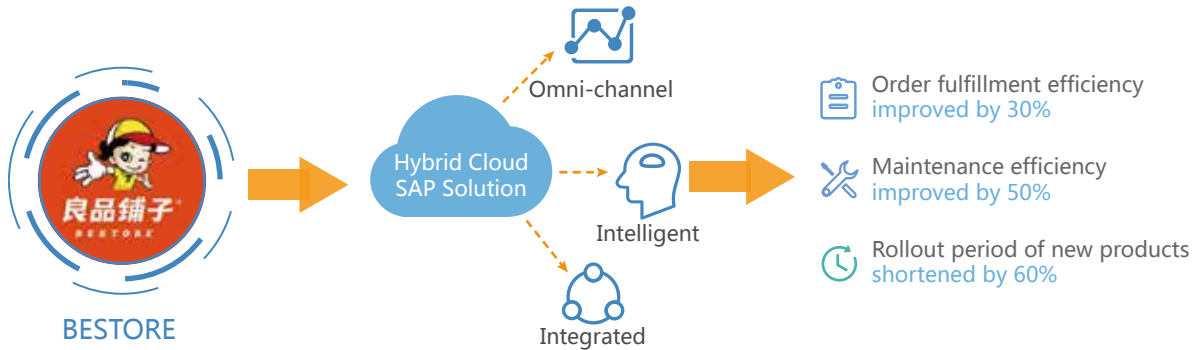

HUAWEI CLOUD SAP on Cloud Solutions Simplify IT O&M, Helping Harbin Pharmaceutical Group Focus on Their Core Business

SAP S/4HANA 1709 | SAP on DeC | New Implementation

When we at Harbin Pharmaceutical Group (HPGC) needed to solve our IT infrastructure problems, we decided to outsource the work to a strategic partner with expertise in this field. This allowed us to focus on our core business.

— Hao Shijun, General Manager of HPGC



HPGC has many branches and subsidiaries, such as HPGC General Factory and HPGC Sanjing. The group also has a research institution that is a key player in pharmaceutical innovation. In 2017, the group's sales income reached nearly \$2 billion, with a net profit of about \$60 million. R&D investment stood at about \$30 million, and its income accounted for 5% of the total revenue of the pharmaceutical industry in China.

Challenges

Difficult information synergy

Each HPGC branch factory builds its own digital information platform, and the used software version and APIs are different. As a result, data integration and information synergy among the branch factories become difficult, HPGC cannot quickly obtain status data, and the platforms cannot support fast decision-making.

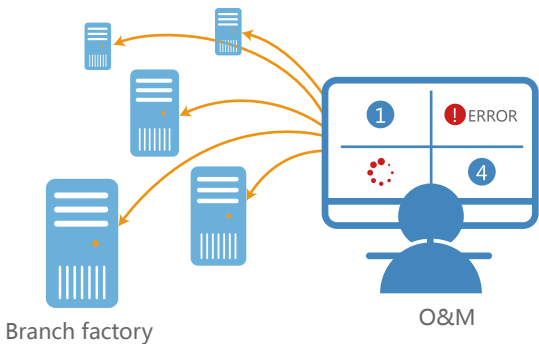
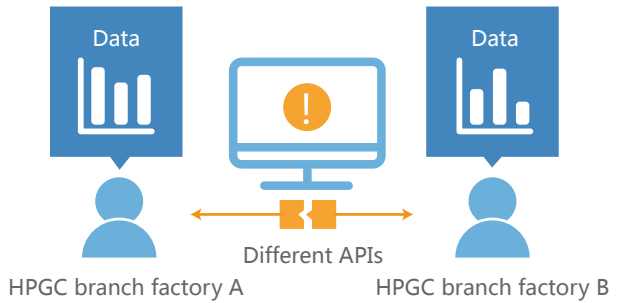

Scattered O&M

The systems of each branch factory are scattered in local data centers. O&M personnel need to maintain these systems simultaneously, making O&M difficult and error-prone. When a system becomes faulty, the vendors are slow to respond.

Why HUAWEI CLOUD SAP?

HPGC hopes to find a professional infrastructure provider to handle system design, deployment, and O&M, allowing HPGC to focus on its core business. After comparing various cloud service providers, server vendors, and hosting vendors in China, HPGC finally chose Huawei SAP on Cloud solution.

Optimal Performance

HPGC branches and the group both need to access the SAP development, test, and production systems. Therefore system reliability and performance must be extremely high. In addition, with the growth of services, HPGC needs the system to scale up and out. HUAWEI CLOUD SAP on DeC solution features ultra-large memory and vertical and horizontal expansion flexibility, meeting current service deployment and processing requirements.

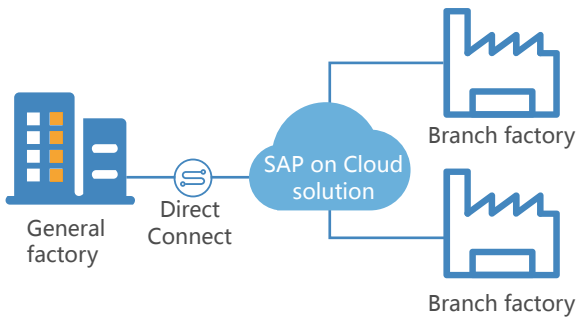
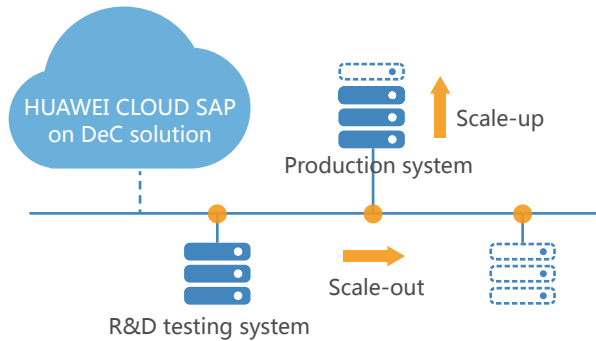

High Reliability

The SAP on Cloud solution supports SAP HA, cluster deployment, and automatic switchovers of Direct Connect and VPN connections, improving system reliability. In addition, the Direct Connect connections between a factory and HUAWEI CLOUD or another factory can be automatically switched to reduce the service interruption time when the line is faulty. This improves user experience.

High Security

DeC is deployed in the Tier3+ data center in North China. The SAP system is deployed in the VPC and isolated by firewalls and security groups. The Anti-DDoS, WAF, and enterprise host security services are used for security protection.

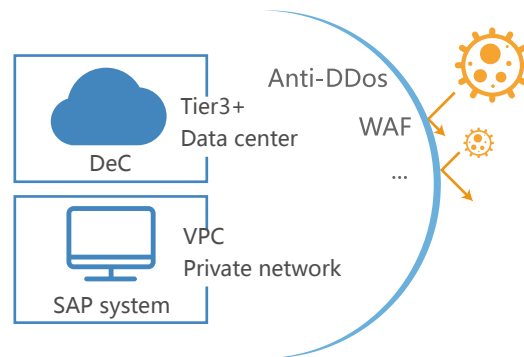

Customer Benefits

The HUAWEI CLOUD DeC solution meets HPGC's security, performance, reliability, and scalability requirements. We used HUAWEI CLOUD for half a year and are very satisfied with their solutions and services. Huawei is very helpful in the overall system O&M. We are considering migrating more services deployed in local and mobile equipment rooms to HUAWEI CLOUD so Huawei can help us maintain and manage them.

— Vice President of HPGC



100+ Enterprises Are Using the HUAWEI CLOUD SAP on Cloud Solution

Retail	Manufacturing	Healthcare	Automobile	Real estate
 良品铺子 BESTORE	 UK by UNIVERSE FILTER	 哈药集团有限公司 HARBIN PHARMACEUTICAL GROUP CO., LTD.	 Vision Tool & Mould	 R&F 富力地产
	 HIGHLY 海立	 高济医疗 Cowell Health	 捷通达 JETONDA	 越秀 YUEXIU
 蒙牛	 TOPSTAR 拓斯达	 SPH 上海医药 SHANGHAI PHARMA	 NIO	
Petrochemical	Energy	High-tech	Public services	Agriculture
 山东中化工程技术有限公司 SHANDONG SINO-CHEMICAL ENGINEERING TECHNOLOGY CO., LTD.	 北京首创股份有限公司 BEIJING CAPITAL CO., LTD.	 SHOOJIN	 中国东方航空 CHINA EASTERN	 丰控集团 FENG KONG GROUP
 Distrocuyo	 长丰能源 CHANGFENG ENERGY	 SOMA	 GLORIA	 正大康地 CHIA TAI CONTI
 Boehringer Ingelheim		 ASKPCB 奥士康	 ITBA	 ZUSF VitalOrganism 朱师傅

Copyright © Huawei Technologies Co., Ltd. 2019. All rights reserved.

No part of this document may be reproduced or transmitted in any form or by any means without prior written consent of Huawei Technologies Co., Ltd.

Trademarks

 **HUAWEI** and  are trademarks of Huawei Technologies Co., Ltd. All other trademarks and trade names mentioned in this document are the property of their respective holders.

Disclaimer

The information in this document may contain predictive statements, including but not limited to, statements regarding the future financial and operating results, future product portfolios, new technologies, etc. There are a number of factors that could cause actual results and developments to differ materially from those expressed or implied in the predictive statements. Therefore, such information is provided for reference purpose only, and constitutes neither an offer nor an commitment. Huawei may change the information at any time without notice, and is not responsible for any liabilities arising from your use of any of the information provided herein.



SAP on Cloud

Huawei Technologies Co., Ltd.

Address: Huawei Industrial Base
Bantian, Longgang
Shenzhen 518129
People's Republic of China

Hotline: +86 4000-955-988

Website: <https://intl.huaweicloud.com/?locale=en-us>